

Varenummer: 3901044010200
 Beskrivelse: Snekkegear med fri indgangsaksel
 VF 44A-10-HS

Mål

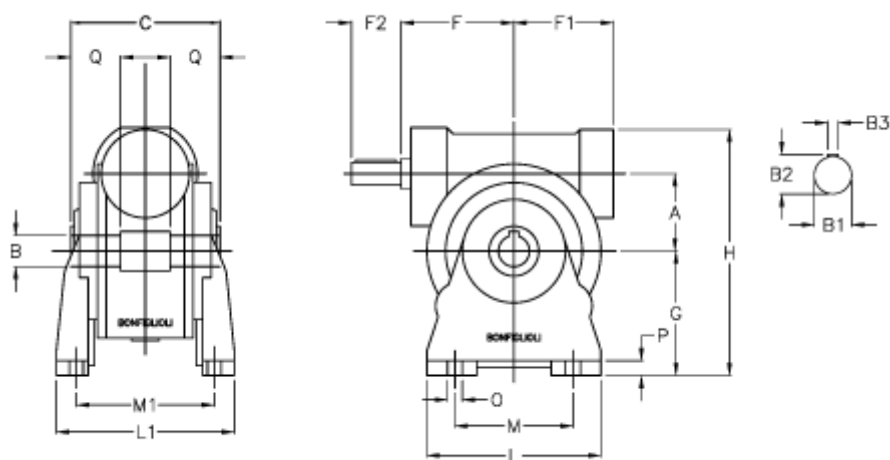

a	= 44.6	F1 = 54	P = 10
B	= 18	g = 72	Q = 24.5
B1 E7	= 11	H = 143	
B2	= 12.5	L = 90	
B3 H9	= 4	L1 = 98	
Betegnelse = VF 44A-xx-HS		m = 52	
C	= 64	M1 = 81.0	
F	= 54.0	O = 8.5	